

Article number: 6100110051011

Description: 08B1

A1 angled one hole attachment link, spring clip type

Measures

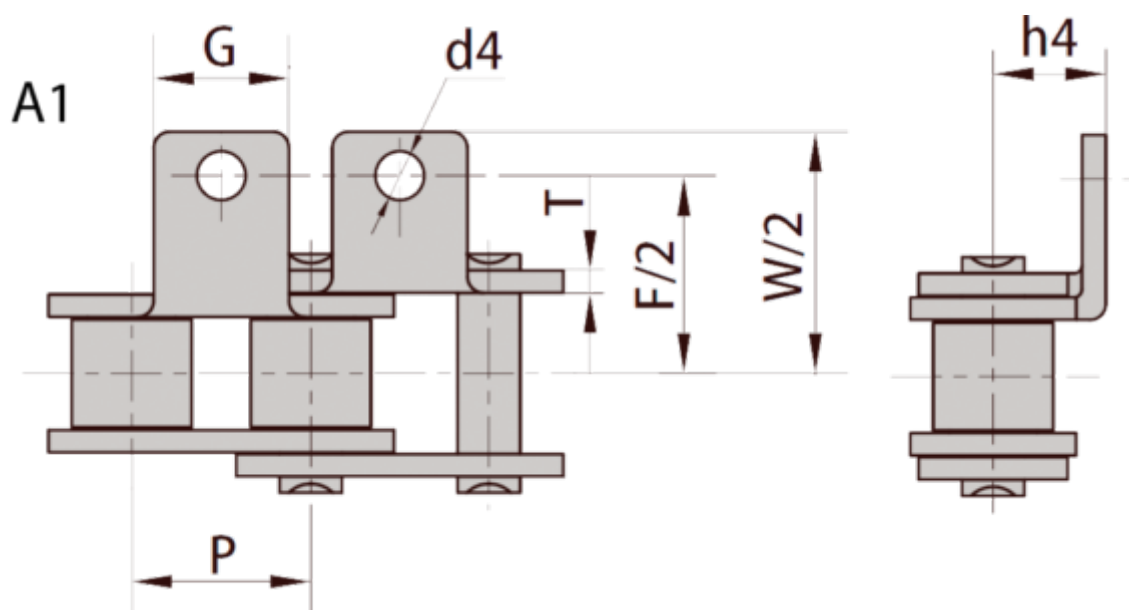

d4 = 4.5

F = 25.40

G = 9.5

h4 = 8.90

P = 12.700

T = 1.60

W = 36.4